

1850-1910 MHz Low Noise Amplifier

General Description

The NLC00359 is a Low Noise Amplifier for PCS Systems. It has very reliable characteristics in over all temperature range. Its DC feed line includes EMI filter so that the unit is protected from a sudden impact from power supply.

Performance with -40 ~ +70 degC

Parameter	Min.	Typ.	Max.	Units
Frequency	1850		1910	MHz
Gain at room temperature	27		29	dB
Gain Flatness over all frequency range at room temperature			±0.5	dB
Noise Figure over all temperature range			1.2	dB
1 dB Compression Point at room temperature		18		dBm
Output Third Order Intercept Point @ +10 dBm output power /tone, room temperature	35			dBm
Input VSWR			1.5 : 1	
Output VSWR			1.5 : 1	
DC supply voltage (Vcc)	+5		+15	V
Supplied Current			270	mA
Operating Temperature	-40		+70	degC

1850-1910 MHz Low Noise Amplifier

Outline Drawing

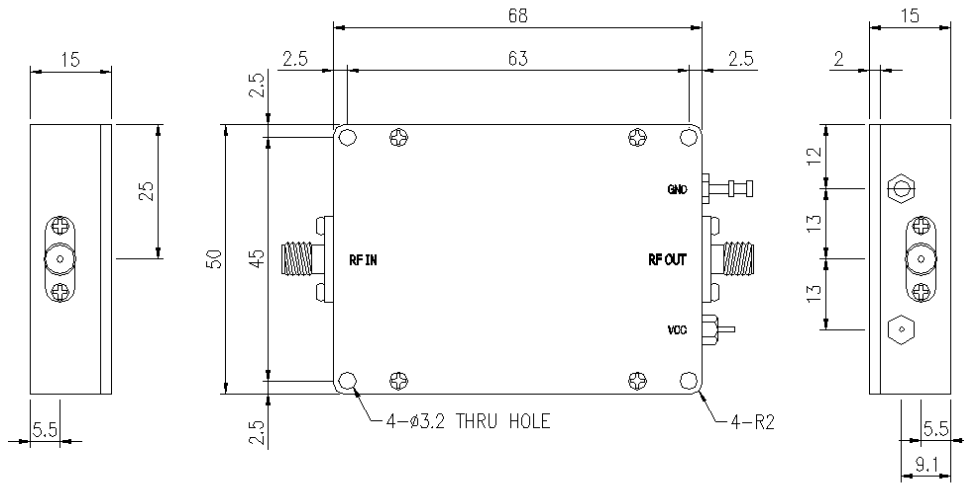

(unit: mm)

Connector Description

RFin	RF input signal (SMA-F)
RFout	RF output signal (SMA-F)
Vdc,	DC Supply Voltage (+5 ~ +15 V)